

# Si/SiC Hybrid Module – EliteSiC™, 3-channel Boost, Q1 Package

## NXH240B120H3Q1P1G, NXH240B120H3Q1S1G

The NXH240B120H3Q1 is a case power module containing a three channel BOOST stage. The integrated field stop trench IGBTs and SiC Diodes provide lower conduction losses and switching losses, enabling designers to achieve high efficiency and superior reliability.

### Features

- 1200 V Ultra Field Stop IGBTs
- Low Reverse Recovery and Fast Switching SiC Diodes
- Low Inductive Layout
- Press-fit Pins / Solder Pins
- Thermistor

### Typical Applications

- Solar Inverters
- ESS

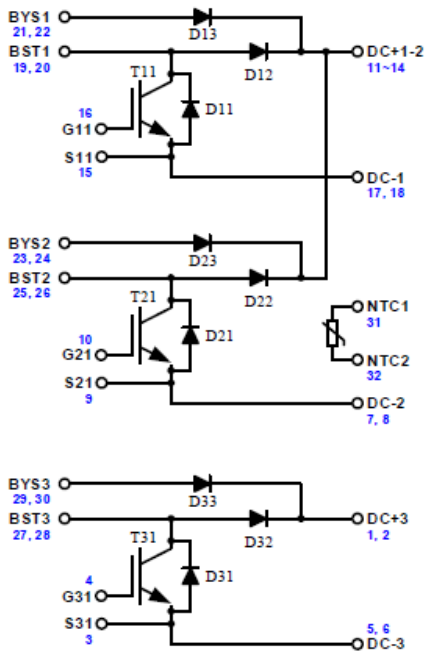
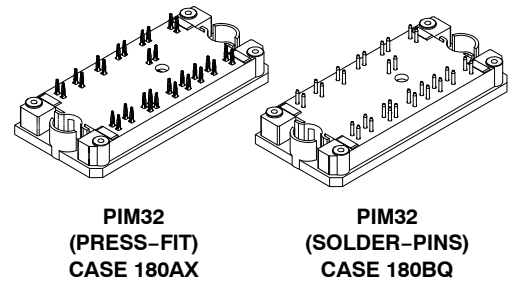
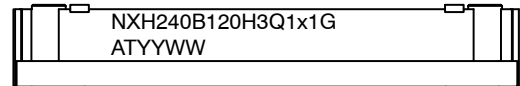

Figure 1. NXH240B120H3Q1  
Schematic Diagram



### MARKING DIAGRAM



NXH240B120H3Q1x1G = Specific Device Code  
x = P or S  
G = Pb-Free Package  
AT = Assembly & Test Site Code  
YYWW = Year and Work Week Code

### PIN CONNECTIONS

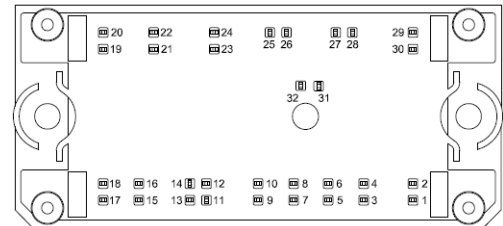

### ORDERING INFORMATION

See detailed ordering and shipping information in the package dimensions section on page 4 of this data sheet.

# NXH240B120H3Q1P1G, NXH240B120H3Q1S1G

**Table 1. MAXIMUM RATINGS** (Note 1)

Rating	Symbol	Value	Unit
<b>IGBT (T11, T21, T31)</b>			
Collector–Emitter Voltage	$V_{CES}$	1200	V
Gate–Emitter Voltage	$V_{GE}$	±20	V
Continuous Collector Current @ $T_C = 80^\circ\text{C}$ ( $T_J = 150^\circ\text{C}$ )	$I_C$	92	A
Pulsed Collector Current ( $T_J = 150^\circ\text{C}$ )	$I_{Cpulse}$	276	A
Maximum Power Dissipation ( $T_J = 150^\circ\text{C}$ )	$P_{tot}$	266	W
Minimum Operating Junction Temperature	$T_{JMIN}$	-40	°C
Maximum Operating Junction Temperature	$T_{JMAX}$	150	°C

**PROTECTION DIODE (D11, D21, D31)**

Peak Repetitive Reverse Voltage	$V_{RRM}$	1200	V
Continuous Forward Current @ $T_C = 80^\circ\text{C}$ ( $T_J = 150^\circ\text{C}$ )	$I_F$	41	A
Repetitive Peak Forward Current ( $T_J = 150^\circ\text{C}$ )	$I_{FRM}$	123	A
Maximum Power Dissipation ( $T_J = 150^\circ\text{C}$ )	$P_{tot}$	54	W
Minimum Operating Junction Temperature	$T_{JMIN}$	-40	°C
Maximum Operating Junction Temperature	$T_{JMAX}$	150	°C

**SILICON CARBIDE BOOST DIODE (D12, D22, D32)**

Peak Repetitive Reverse Voltage	$V_{RRM}$	1200	V
Continuous Forward Current @ $T_C = 80^\circ\text{C}$ ( $T_J = 175^\circ\text{C}$ )	$I_F$	37	A
Repetitive Peak Forward Current ( $T_J = 175^\circ\text{C}$ )	$I_{FRM}$	111	A
Maximum Power Dissipation ( $T_J = 175^\circ\text{C}$ )	$P_{tot}$	99	W
Minimum Operating Junction Temperature	$T_{JMIN}$	-40	°C
Maximum Operating Junction Temperature	$T_{JMAX}$	175	°C

**BYPASS DIODE (D13, D23, D33)**

Peak Repetitive Reverse Voltage	$V_{RRM}$	1200	V
Continuous Forward Current @ $T_C = 80^\circ\text{C}$ ( $T_J = 150^\circ\text{C}$ )	$I_F$	54	A
Repetitive Peak Forward Current ( $T_J = 150^\circ\text{C}$ )	$I_{FRM}$	162	A
Maximum Power Dissipation ( $T_J = 150^\circ\text{C}$ )	$P_{tot}$	64	W
Minimum Operating Junction Temperature	$T_{JMIN}$	-40	°C
Maximum Operating Junction Temperature	$T_{JMAX}$	150	°C

**THERMAL PROPERTIES**

Storage Temperature range	$T_{stg}$	-40 to 150	°C
---------------------------	-----------	------------	----

**INSULATION PROPERTIES**

Isolation test voltage, $t = 1$ sec, 60 Hz	$V_{is}$	3000	$V_{RMS}$
Creepage distance		12.7	mm

Stresses exceeding those listed in the Maximum Ratings table may damage the device. If any of these limits are exceeded, device functionality should not be assumed, damage may occur and reliability may be affected.

1. Refer to ELECTRICAL CHARACTERISTICS, RECOMMENDED OPERATING RANGES and/or APPLICATION INFORMATION for Safe Operating parameters.

**Table 2. RECOMMENDED OPERATING RANGES**

Rating	Symbol	Min	Max	Unit
Module Operating Junction Temperature	$T_J$	-40	150	°C

Functional operation above the stresses listed in the Recommended Operating Ranges is not implied. Extended exposure to stresses beyond the Recommended Operating Ranges limits may affect device reliability.

# NXH240B120H3Q1P1G, NXH240B120H3Q1S1G

**Table 3. ELECTRICAL CHARACTERISTICS** ( $T_J = 25^\circ\text{C}$  unless otherwise noted)

Parameter	Test Conditions	Symbol	Min	Typ	Max	Unit
<b>IGBT (T11, T21, T31)</b>						
Collector–Emitter Cutoff Current	$V_{GE} = 0\text{ V}, V_{CE} = 1200\text{ V}$	$I_{CES}$	–	–	150	$\mu\text{A}$
Collector–Emitter Saturation Voltage	$V_{GE} = 15\text{ V}, I_C = 80\text{ A}, T_J = 25^\circ\text{C}$	$V_{CE(sat)}$	–	2	2.7	V
	$V_{GE} = 15\text{ V}, I_C = 80\text{ A}, T_J = 150^\circ\text{C}$		–	2.05	–	
Gate–Emitter Threshold Voltage	$V_{GE} = V_{CE}, I_C = 80\ \mu\text{A}$	$V_{GE(TH)}$	4.2	5.2	6	V
Gate Leakage Current	$V_{GE} = 20\text{ V}, V_{CE} = 0\text{ V}$	$I_{GES}$	–	–	450	nA
Turn-on Delay Time	$T_J = 25^\circ\text{C}$ $V_{CE} = 800\text{ V}, I_C = 50\text{ A}$ $V_{GE} = +15\text{ V}, -9\text{ V}, R_G = 6\ \Omega$	$t_{d(on)}$	–	100.51	–	ns
Rise Time		$t_r$	–	31.95	–	
Turn-off Delay Time		$t_{d(off)}$	–	377.15	–	
Fall Time		$t_f$	–	38.27	–	
Turn-on Switching Loss per Pulse		$E_{on}$	–	1660	–	
Turn off Switching Loss per Pulse	$E_{off}$	–	2470	–		
Turn-on Delay Time	$T_J = 125^\circ\text{C}$ $V_{CE} = 800\text{ V}, I_C = 50\text{ A}$ $V_{GE} = +15\text{ V}, -9\text{ V}, R_G = 6\ \Omega$	$t_{d(on)}$	–	89.65	–	ns
Rise Time		$t_r$	–	32	–	
Turn-off Delay Time		$t_{d(off)}$	–	440.78	–	
Fall Time		$t_f$	–	169.39	–	
Turn-on Switching Loss per Pulse		$E_{on}$	–	1660	–	
Turn off Switching Loss per Pulse	$E_{off}$	–	5220	–		
Input Capacitance	$V_{CE} = 20\text{ V}, V_{GE} = 0\text{ V}, f = 10\text{ kHz}$	$C_{ies}$	–	19082	–	pF
Output Capacitance		$C_{oes}$	–	541	–	
Reverse Transfer Capacitance		$C_{res}$	–	387	–	
Total Gate Charge	$V_{CE} = 600\text{ V}, I_C = 25\text{ A}, V_{GE} = \pm 15\text{ V}$	$Q_g$	–	1320	–	nC
Thermal Resistance – chip-to–heatsink	Thermal grease, Thickness = 2 Mil $\pm 2\%$ , $\lambda = 2.87\text{ W/mK}$	$R_{thJH}$	–	0.464	–	$^\circ\text{C/W}$
Thermal Resistance – chip-to–case		$R_{thJC}$	–	0.263	–	$^\circ\text{C/W}$
<b>PROTECTION DIODE (D11, D21, D31)</b>						
Diode Forward Voltage	$I_F = 30\text{ A}, T_J = 25^\circ\text{C}$	$V_F$	0.8	1.0	1.3	V
	$I_F = 30\text{ A}, T_J = 150^\circ\text{C}$		–	0.98	–	
Thermal Resistance – chip-to–heatsink	Thermal grease, Thickness = 2 Mil $\pm 2\%$ , $\lambda = 2.87\text{ W/mK}$	$R_{thJH}$	–	1.303	–	$^\circ\text{C/W}$
Thermal Resistance – chip-to–case		$R_{thJC}$	–	0.968	–	$^\circ\text{C/W}$
<b>SILICON CARBIDE BOOST DIODE (D12, D22, D32)</b>						
Diode Forward Voltage	$I_F = 30\text{ A}, T_J = 25^\circ\text{C}$	$V_F$	–	1.46	1.7	V
	$I_F = 30\text{ A}, T_J = 175^\circ\text{C}$		–	2.12	–	
Reverse Recovery Time	$T_J = 25^\circ\text{C}$ $V_{CE} = 800\text{ V}, I_C = 50\text{ A}$ $V_{GE} = +15\text{ V}, -9\text{ V}, R_G = 6\ \Omega$	$t_{rr}$	–	21.5	–	ns
Reverse Recovery Charge		$Q_{rr}$	–	87.82	–	$\mu\text{C}$
Peak Reverse Recovery Current		$I_{RRM}$	–	7.21	–	A
Peak Rate of Fall of Recovery Current		$di/dt$	–	1282.75	–	$\text{A}/\mu\text{s}$
Reverse Recovery Energy		$E_{rr}$	–	23.61	–	$\mu\text{J}$
Reverse Recovery Time	$T_J = 125^\circ\text{C}$ $V_{CE} = 800\text{ V}, I_C = 50\text{ A}$ $V_{GE} = +15\text{ V}, -9\text{ V}, R_G = 6\ \Omega$	$t_{rr}$	–	25.73	–	ns
Reverse Recovery Charge		$Q_{rr}$	–	108.23	–	$\mu\text{C}$
Peak Reverse Recovery Current		$I_{RRM}$	–	7.6	–	A
Peak Rate of Fall of Recovery Current		$di/dt$	–	1275.94	–	$\text{A}/\mu\text{s}$
Reverse Recovery Energy		$E_{rr}$	–	30.68	–	$\mu\text{J}$

## NXH240B120H3Q1P1G, NXH240B120H3Q1S1G

**Table 3. ELECTRICAL CHARACTERISTICS** ( $T_J = 25^\circ\text{C}$  unless otherwise noted)

Parameter	Test Conditions	Symbol	Min	Typ	Max	Unit
-----------	-----------------	--------	-----	-----	-----	------

### SILICON CARBIDE BOOST DIODE (D12, D22, D32)

Thermal Resistance – chip-to-heatsink	Thermal grease, Thickness = 2 Mil $\pm 2\%$ , $\lambda = 2.87$ W/mK	$R_{thJH}$	–	0.958	–	$^\circ\text{C/W}$
Thermal Resistance – chip-to-case		$R_{thJC}$	–	0.682	–	$^\circ\text{C/W}$

### BYPASS DIODE (D13, D23, D33)

Diode Forward Voltage	$I_F = 50$ A, $T_J = 25^\circ\text{C}$	$V_F$	–	1.1	1.3	V
	$I_F = 50$ A, $T_J = 150^\circ\text{C}$		–	0.95	–	
Thermal Resistance – chip-to-heatsink	Thermal grease, Thickness = 2 Mil $\pm 2\%$ , $\lambda = 2.87$ W/mK	$R_{thJH}$	–	1.095	–	$^\circ\text{C/W}$
Thermal Resistance – chip-to-case		$R_{thJC}$	–	0.767	–	$^\circ\text{C/W}$

### THERMISTOR CHARACTERISTICS

Nominal resistance	$T = 25^\circ\text{C}$	$R_{25}$	–	5	–	$\text{k}\Omega$
Nominal resistance	$T = 100^\circ\text{C}$	$R_{100}$	–	490.6	–	$\Omega$
Deviation of R25		$\Delta R/R$	–1	–	1	%
Power dissipation		$P_D$	–	5	–	mW
Power dissipation constant			–	1.3	–	mW/K
B-value	B(25/85), tolerance $\pm 1\%$		–	3435	–	K

Product parametric performance is indicated in the Electrical Characteristics for the listed test conditions, unless otherwise noted. Product performance may not be indicated by the Electrical Characteristics if operated under different conditions.

### ORDERING INFORMATION

Orderable Part Number	Marking	Package	Shipping
NXH240B120H3Q1P1G	NXH240B120H3Q1P1G	Q1 BOOST, Case 180AX Press-fit Pins (Pb-Free)	21 Units / Blister Tray
NXH240B120H3Q1S1G	NXH240B120H3Q1S1G	Q1 BOOST, Case 180BQ Solder Pins (Pb-Free)	21 Units / Blister Tray

# NXH240B120H3Q1P1G, NXH240B120H3Q1S1G

## TYPICAL CHARACTERISTICS – IGBT (T1, T2, T3) AND SILICON CARBIDE SCHOTTKY DIODE (D12, D22, D32)

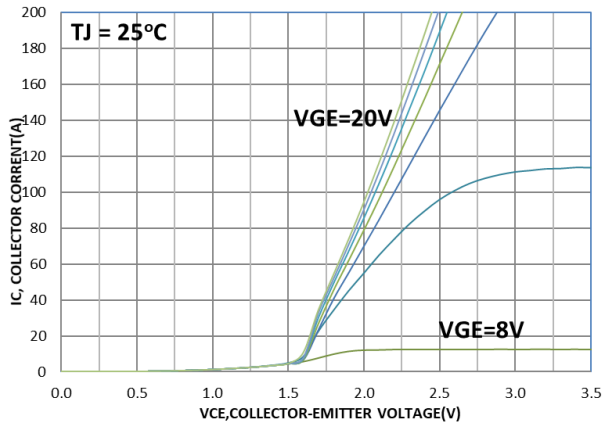

Figure 2. Typical Output Characteristics

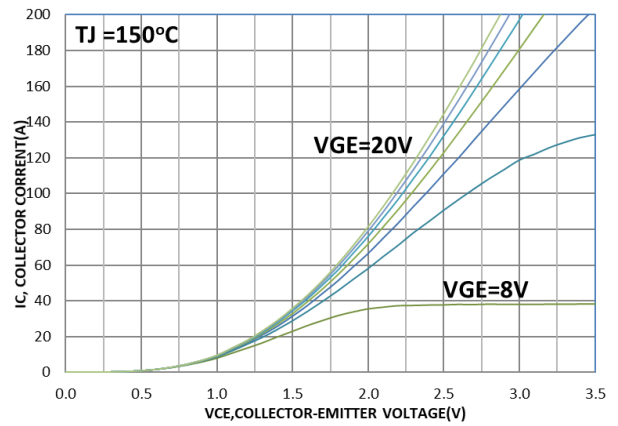

Figure 3. Typical Output Characteristics

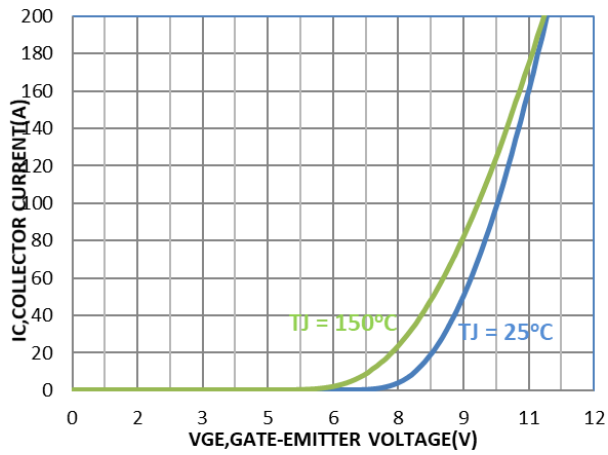

Figure 4. Typical Transfer Characteristics

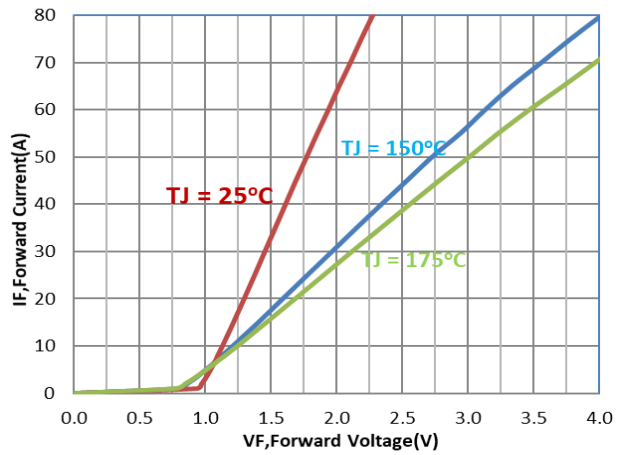

Figure 5. Diode Forward Characteristics

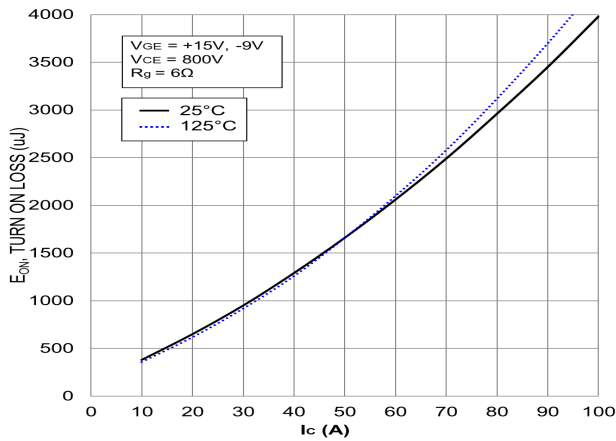

Figure 6. Typical Turn ON Loss vs.  $I_C$

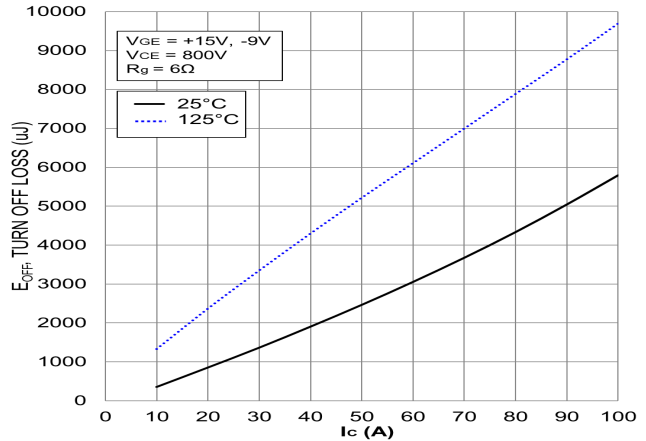

Figure 7. Typical Turn OFF Loss vs.  $I_C$

# NXH240B120H3Q1P1G, NXH240B120H3Q1S1G

## TYPICAL CHARACTERISTICS – IGBT (T1, T2, T3) AND SILICON CARBIDE SCHOTTKY DIODE (D12, D22, D32)

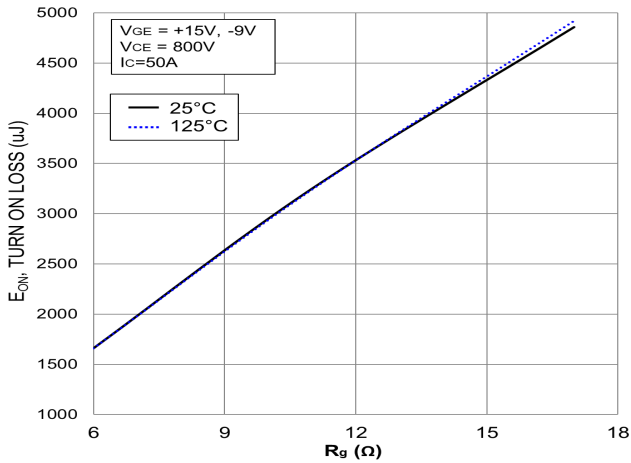

Figure 8. Typical Turn ON Loss vs.  $R_G$

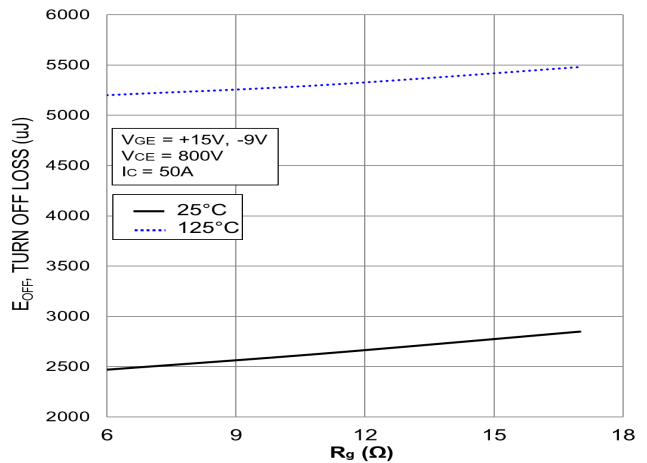

Figure 9. Typical Turn OFF Loss vs.  $R_G$

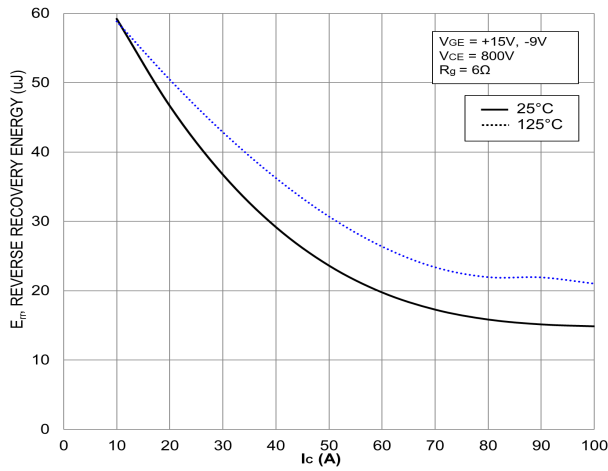

Figure 10. Typical Reverse Recovery Time vs.  $I_C$

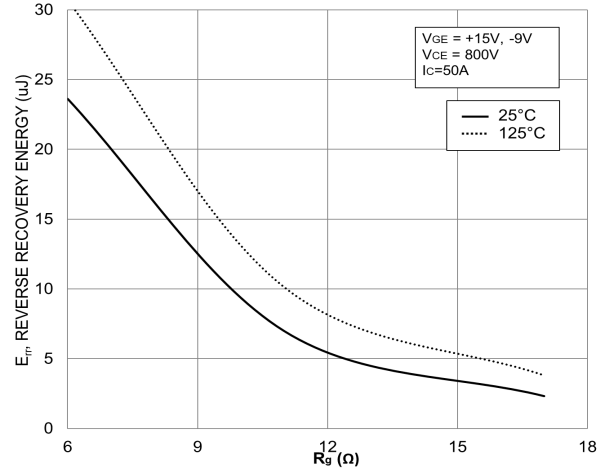

Figure 11. Typical Reverse Recovery Time vs.  $R_G$

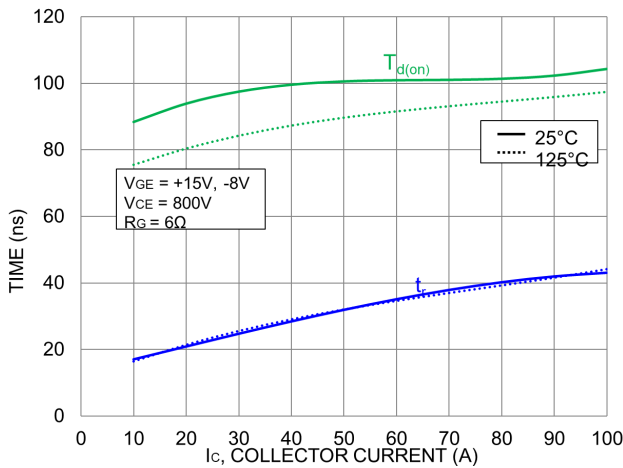

Figure 12. Typical Turn-On Switching Time vs.  $I_C$

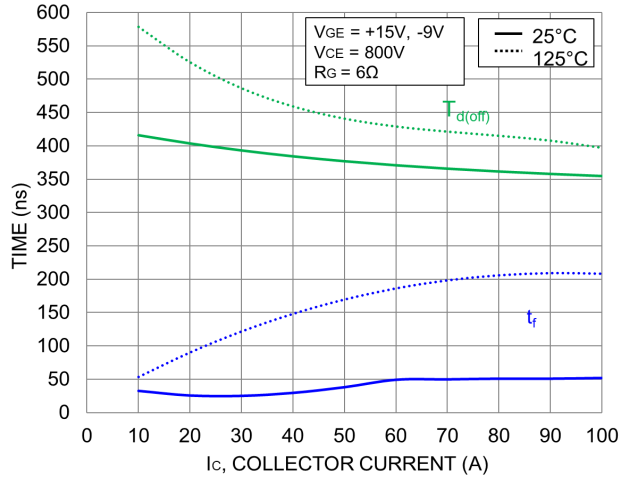

Figure 13. Typical Turn-Off Switching Time vs.  $I_C$

# NXH240B120H3Q1P1G, NXH240B120H3Q1S1G

## TYPICAL CHARACTERISTICS – IGBT (T1, T2, T3) AND SILICON CARBIDE SCHOTTKY DIODE (D12, D22, D32)

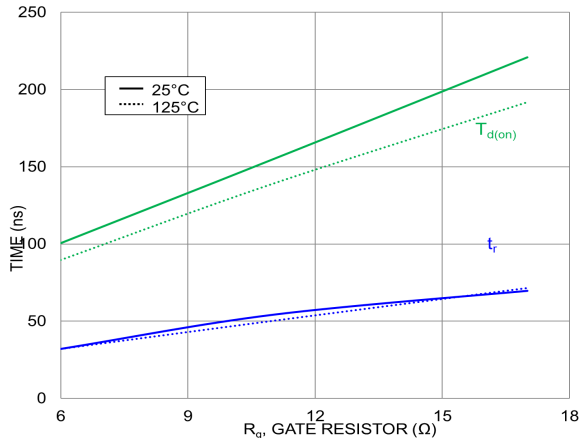

Figure 14. Typical Turn-On Switching Time vs.  $R_G$

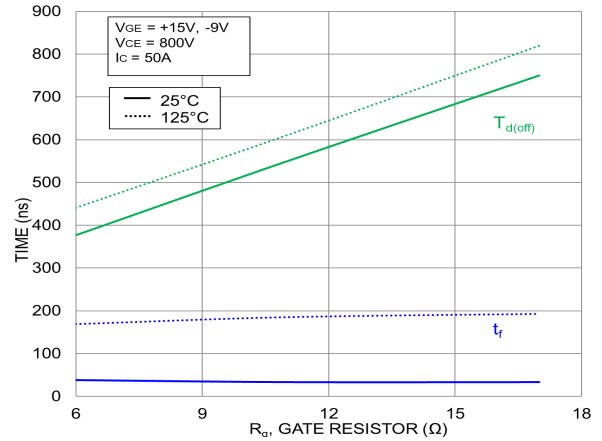

Figure 15. Typical Turn-Off Switching Time vs.  $R_G$

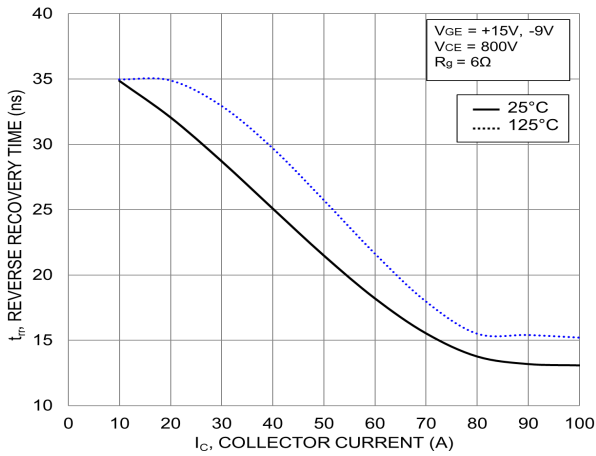

Figure 16. Typical Reverse Recovery Time vs.  $I_C$

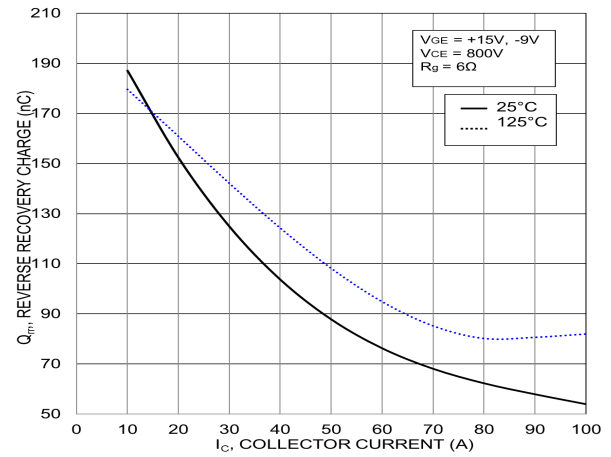

Figure 17. Typical Reverse Recovery Charge vs.  $I_C$

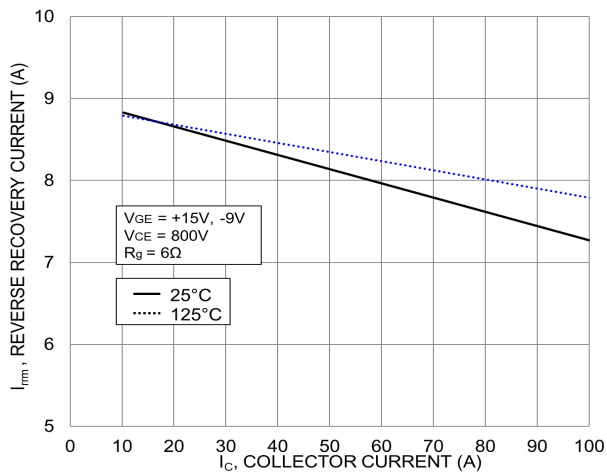

Figure 18. Typical Reverse Recovery Peak Current vs.  $I_C$

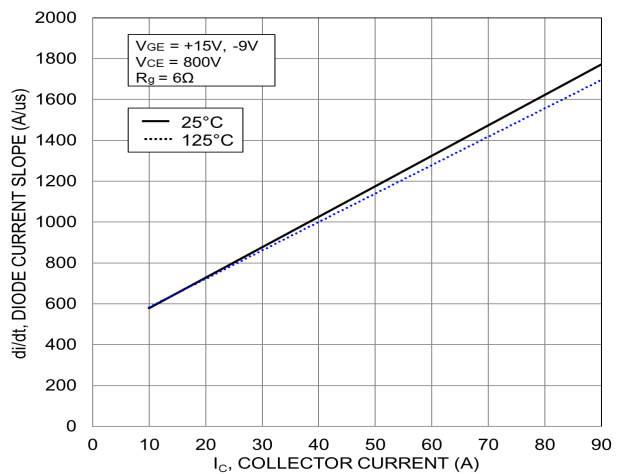

Figure 19. Typical  $di/dt$  vs.  $I_C$

# NXH240B120H3Q1P1G, NXH240B120H3Q1S1G

## TYPICAL CHARACTERISTICS – IGBT (T1, T2, T3) AND SILICON CARBIDE SCHOTTKY DIODE (D12, D22, D32)

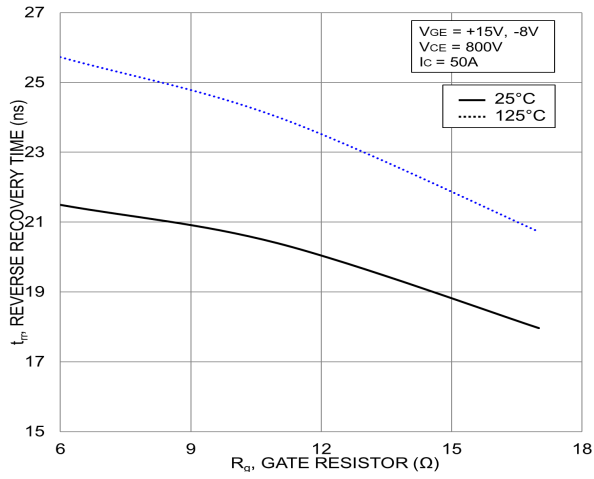

Figure 20. Typical Reverse Recovery Time vs.  $R_G$

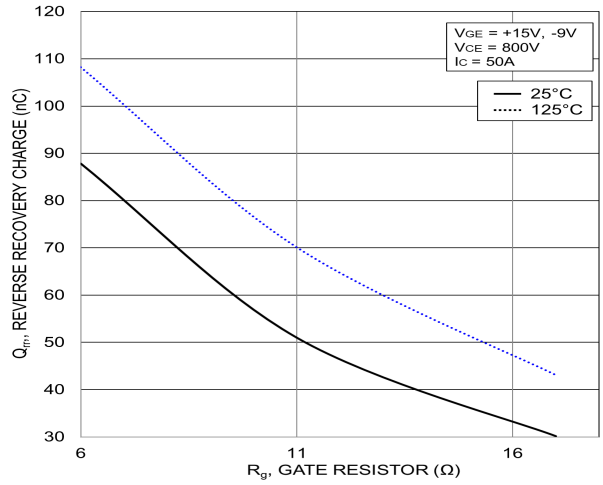

Figure 21. Typical Reverse Recovery Charge vs.  $R_G$

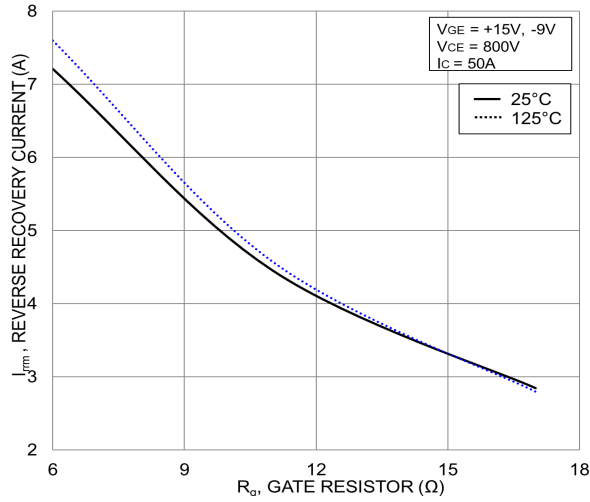

Figure 22. Typical Reverse Recovery Current vs.  $R_G$

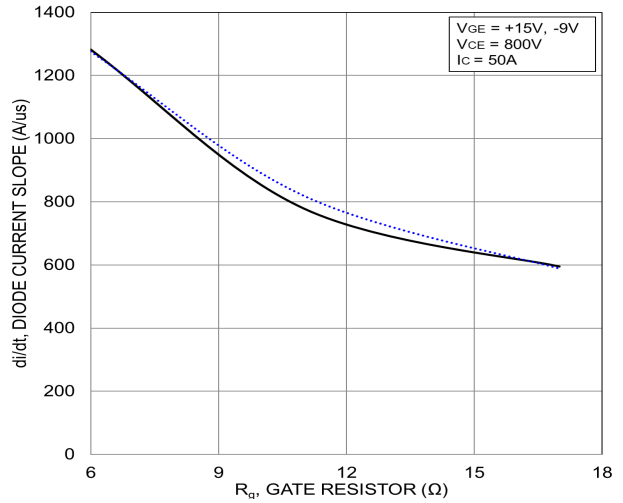

Figure 23. Typical di/dt Current Slope vs.  $R_G$

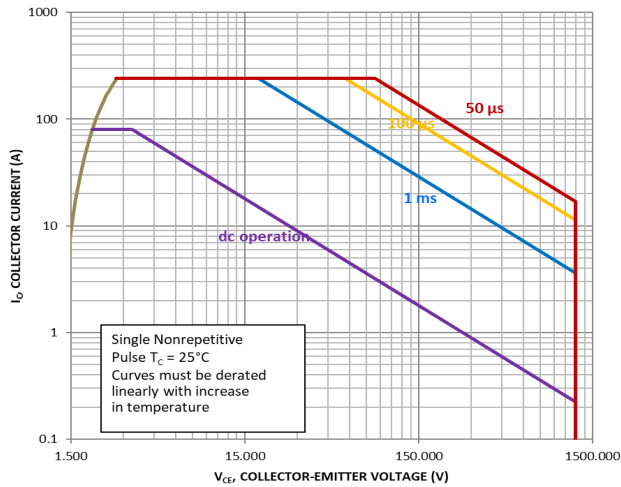

Figure 24. FBSOA

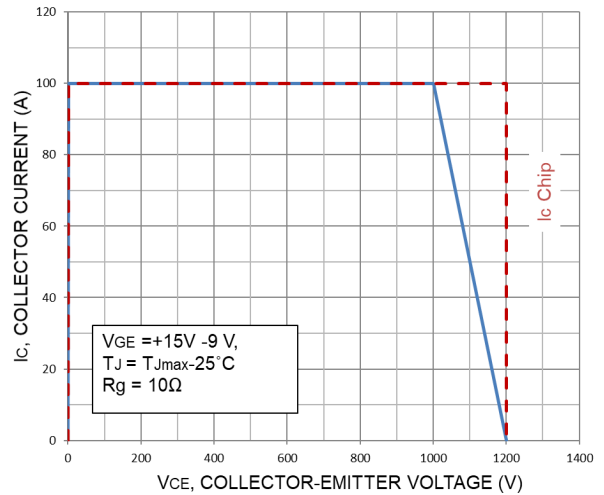

Figure 25. RBSOA



# NXH240B120H3Q1P1G, NXH240B120H3Q1S1G

## TYPICAL CHARACTERISTICS – IGBT (T1, T2, T3) AND SILICON CARBIDE SCHOTTKY DIODE (D12, D22, D32)

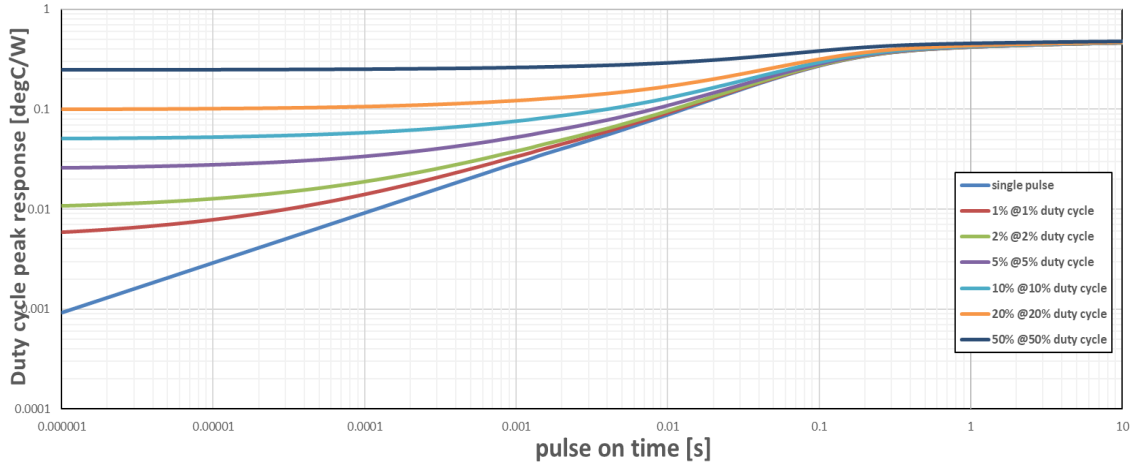

Figure 26. Transient Thermal Impedance (T1, T2, T3)

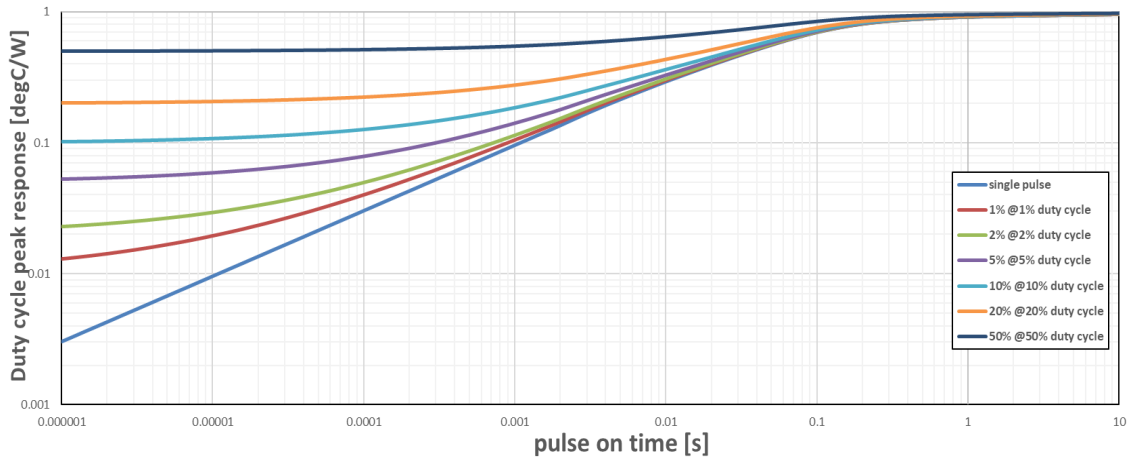

Figure 27. Transient Thermal Impedance (D12, D22, D32)

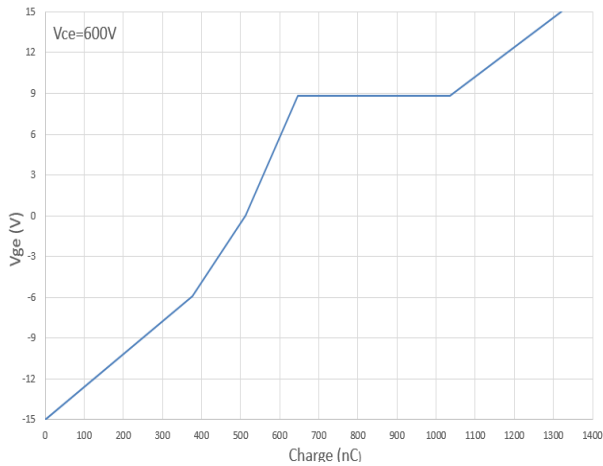

Figure 28. Gate Voltage vs. Gate Charge

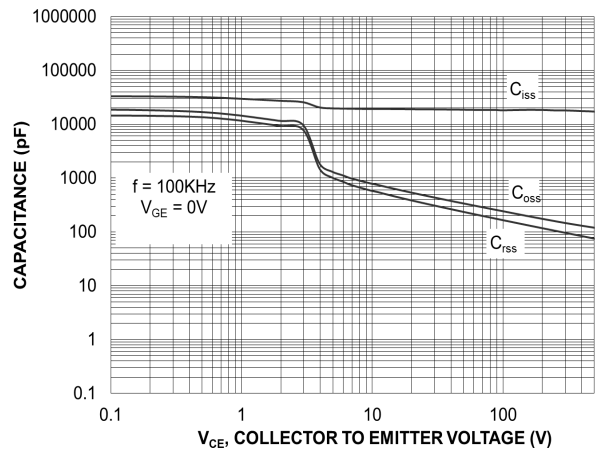

Figure 29. Gate Voltage vs. Gate Charge

# NXH240B120H3Q1P1G, NXH240B120H3Q1S1G

## TYPICAL CHARACTERISTICS – DIODE (D13, D23, D33)

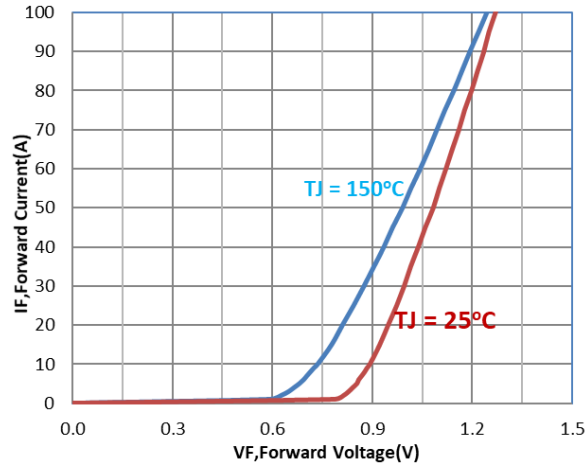

Figure 30. Diode Forward Characteristics

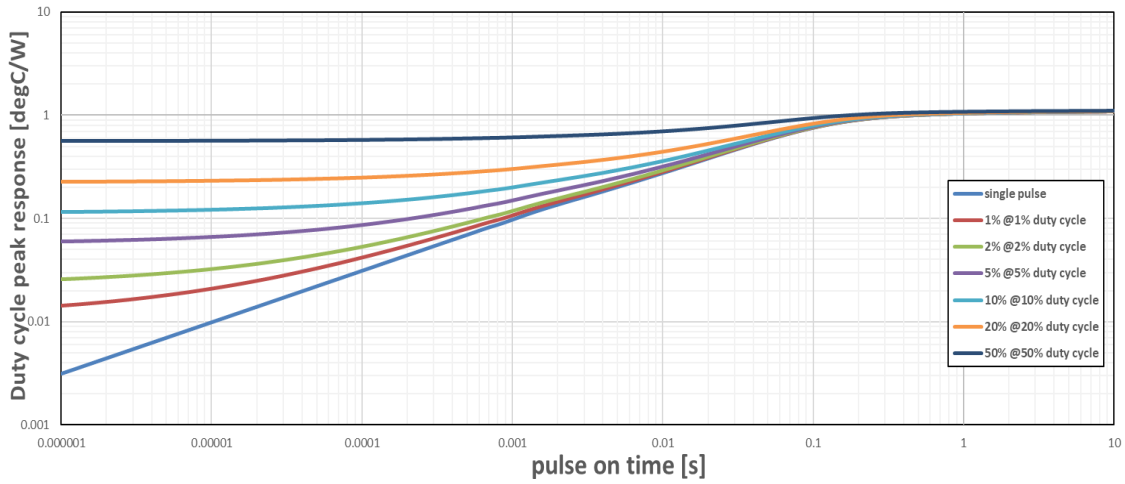

Figure 31. Transient Thermal Impedance

# NXH240B120H3Q1P1G, NXH240B120H3Q1S1G

## TYPICAL CHARACTERISTICS – DIODE (D11, D21, D31)

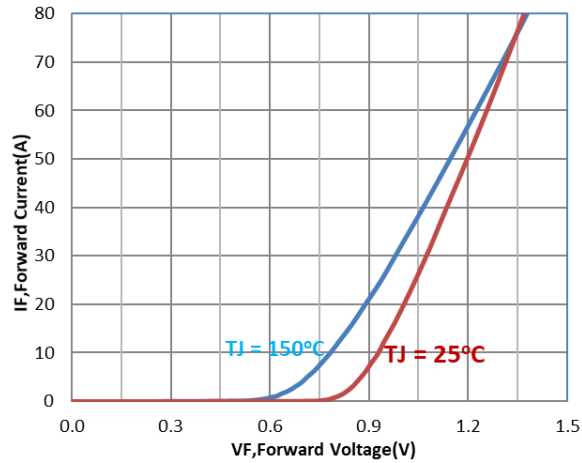

Figure 32. Diode Forward Characteristics

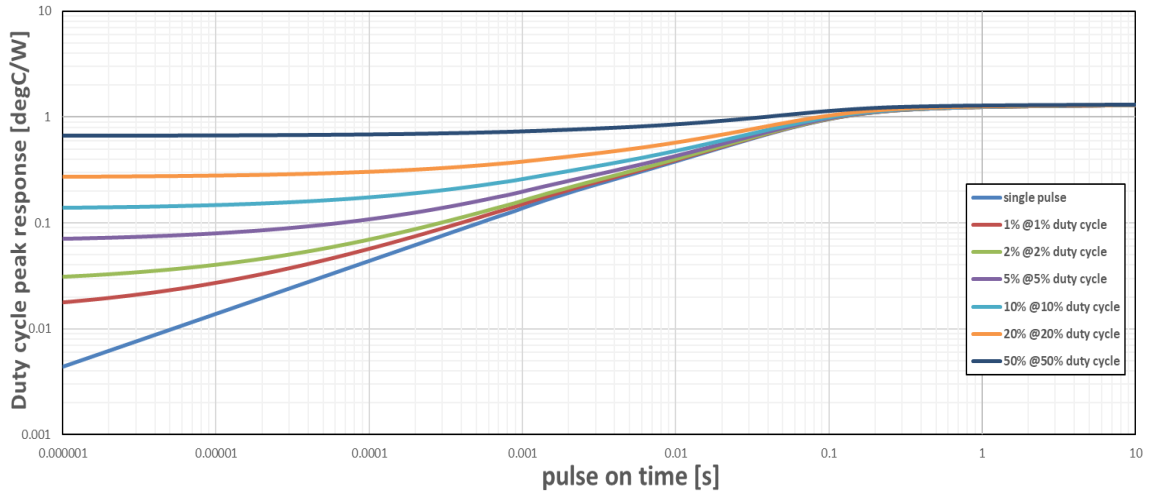

Figure 33. Transient Thermal Impedance

# MECHANICAL CASE OUTLINE PACKAGE DIMENSIONS

ON Semiconductor®



## PIM32, 71x37.4 (PRESS-FIT) CASE 180AX ISSUE O

DATE 25 JAN 2019

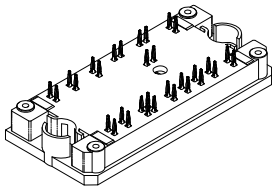

NOTES:

1. DIMENSIONING AND TOLERANCING PER ASME Y14.5M, 2009.
2. CONTROLLING DIMENSION: MILLIMETERS
3. DIMENSIONS b AND b1 APPLY TO THE PLATED TERMINALS AND ARE MEASURED AT DIMENSION A4.
4. POSITION OF THE CENTER OF THE TERMINALS AND MOUNTING HOLES IS DETERMINED FROM DATUM B THE CENTER OF DIMENSION D, X DIRECTION, AND FROM DATUM A, Y DIRECTION. POSITIONAL TOLERANCE, AS NOTED IN DRAWING, APPLIES TO BOTH TERMINALS AND MOUNTING HOLES IN BOTH DIRECTIONS.
5. PACKAGE MARKING IS LOCATED, AS SHOWN, ON THE SIDE OPPOSITE THE PACKAGE ORIENTATION FEATURES.
6. MOUNTING RECOMMENDATION IS SHOWN AS VIEWED FROM THE PCB TOP LAYER LOOKING DOWN TO SUBSEQUENT LAYERS.

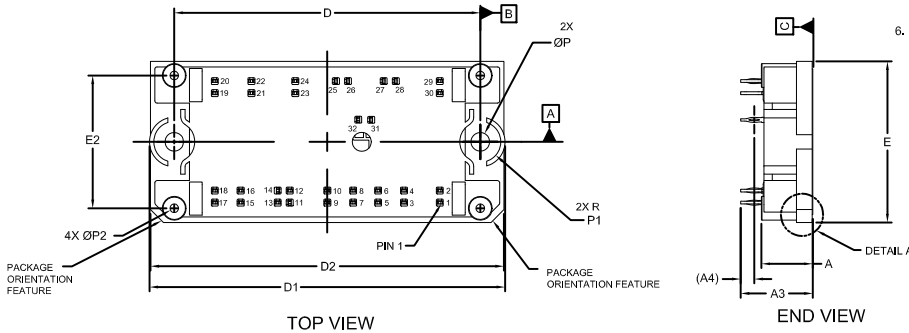

DIM	MILLIMETERS		
	MIN.	NOM.	MAX.
A	11.44	11.94	12.44
A1	10.84	11.34	11.84
A3	16.27	16.77	17.27
A4	3.05	3.15	3.25
A5	0.04	0.24	0.44
b	1.13	1.18	1.23
b1	0.59	0.64	0.69
D	70.50	71.00	71.50
D1	82.00	82.50	83.00
D2	81.50	82.00	82.50
E	36.90	37.40	37.90
E2	30.30	30.80	31.30
P	4.30	4.40	4.50
P1	4.55	4.75	4.95
P2	2.00 REF		

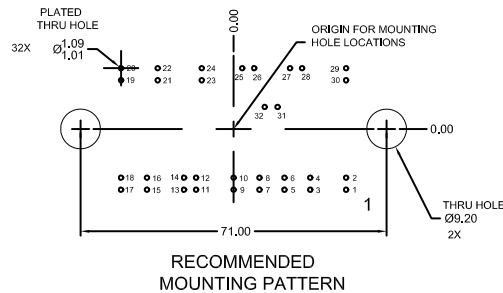
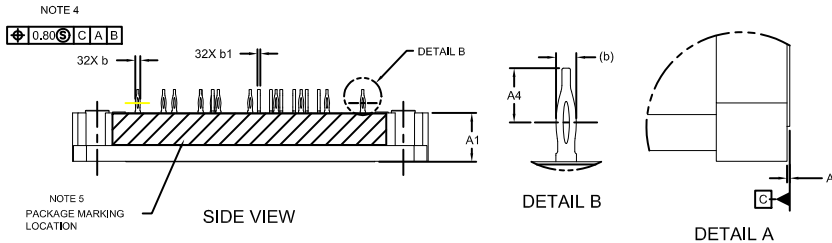

NOTE 4

PIN	PIN POSITION		PIN	PIN POSITION	
	X	Y		X	Y
1	26.10	-14.10	17	-26.10	-14.10
2	26.10	-11.30	18	-26.10	-11.30
3	17.80	-14.10	19	-26.10	11.30
4	17.80	-11.30	20	-26.10	14.10
5	11.80	-14.10	21	-17.60	11.30
6	11.80	-11.30	22	-17.60	14.10
7	6.00	-14.10	23	-7.40	11.30
8	6.00	-11.30	24	-7.40	14.10
9	0.00	-14.10	25	2.00	14.10
10	0.00	-11.30	26	4.80	14.10
11	-8.70	-14.10	27	13.10	14.10
12	-8.70	-11.30	28	15.90	14.10
13	-11.50	-14.10	29	26.10	14.10
14	-11.50	-11.30	30	26.10	11.30
15	-20.10	-14.10	31	10.20	5.10
16	-20.10	-11.30	32	7.20	5.10

### GENERIC MARKING DIAGRAM\*

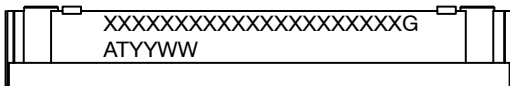

XXXXX = Specific Device Code  
G = Pb-Free Package  
AT = Assembly & Test Site Code  
YYWW = Year and Work Week Code

\*This information is generic. Please refer to device data sheet for actual part marking. Pb-Free indicator, "G" or microdot "▪", may or may not be present. Some products may not follow the Generic Marking.

<b>DOCUMENT NUMBER:</b>	<b>98AON02449H</b>	Electronic versions are uncontrolled except when accessed directly from the Document Repository. Printed versions are uncontrolled except when stamped "CONTROLLED COPY" in red.
<b>DESCRIPTION:</b>	<b>PIM32, 71x37.4 (PRESS-FIT)</b>	<b>PAGE 1 OF 1</b>

ON Semiconductor and ON are trademarks of Semiconductor Components Industries, LLC dba ON Semiconductor or its subsidiaries in the United States and/or other countries. ON Semiconductor reserves the right to make changes without further notice to any products herein. ON Semiconductor makes no warranty, representation or guarantee regarding the suitability of its products for any particular purpose, nor does ON Semiconductor assume any liability arising out of the application or use of any product or circuit, and specifically disclaims any and all liability, including without limitation special, consequential or incidental damages. ON Semiconductor does not convey any license under its patent rights nor the rights of others.

# MECHANICAL CASE OUTLINE PACKAGE DIMENSIONS

ON Semiconductor®



## PIM32, 71x37.4 (SOLDER PIN) CASE 180BQ ISSUE A

DATE 23 JUL 2021

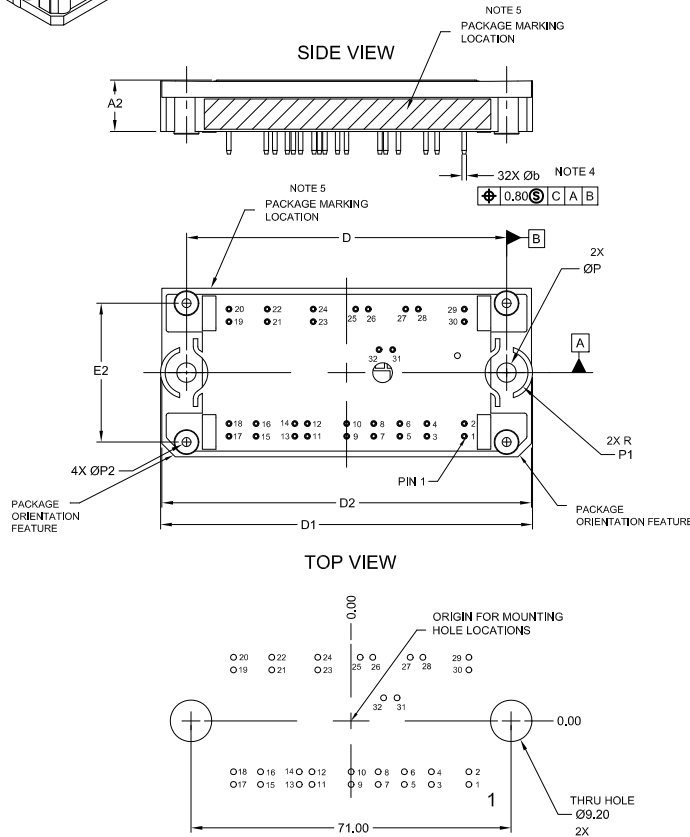
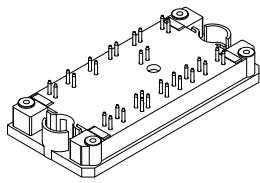

DIM	MILLIMETERS		
	MIN.	NOM.	MAX.
A	11.70	12.00	12.30
A2	10.90	11.40	11.90
A3	15.90	16.40	16.90
A5	0.00	-	0.45
b	0.90	1.00	1.10
D	70.50	71.00	71.50
D1	82.00	82.50	83.00
D2	81.50	82.00	82.50
E	36.90	37.40	37.90
E2	30.30	30.80	31.30
P	4.30	4.40	4.50
P1	4.55	4.75	4.95
P2	2.00 REF		

NOTE 4

PIN	PIN POSITION		PIN	PIN POSITION	
	X	Y		X	Y
1	26.10	-14.10	17	-26.10	-14.10
2	26.10	-11.30	18	-26.10	-11.30
3	17.80	-14.10	19	-26.10	11.30
4	17.80	-11.30	20	-26.10	14.10
5	11.80	-14.10	21	-17.60	11.30
6	11.80	-11.30	22	-17.60	14.10
7	6.00	-14.10	23	-7.40	11.30
8	6.00	-11.30	24	-7.40	14.10
9	0.00	-14.10	25	2.00	14.10
10	0.00	-11.30	26	4.80	14.10
11	-8.70	-14.10	27	13.10	14.10
12	-8.70	-11.30	28	15.90	14.10
13	-11.50	-14.10	29	26.10	14.10
14	-11.50	-11.30	30	26.10	11.30
15	-20.10	-14.10	31	10.20	5.10
16	-20.10	-11.30	32	7.20	5.10

NOTES:

- DIMENSIONING AND TOLERANCING PER ASME Y14.5M, 2009.
- CONTROLLING DIMENSION; MILLIMETERS
- DIMENSION *b* APPLIES TO THE PLATED TERMINALS AND IS MEASURED BETWEEN 1.00 AND 3.00 FROM THE TERMINAL TIP.
- POSITION OF THE CENTER OF THE TERMINALS AND MOUNTING HOLES IS DETERMINED FROM DATUM B THE CENTER OF DIMENSION D, X DIRECTION, AND FROM DATUM A, Y DIRECTION. POSITIONAL TOLERANCE, AS NOTED IN DRAWING, APPLIES TO BOTH TERMINALS AND MOUNTING HOLES IN BOTH DIRECTIONS.
- PACKAGE MARKING IS LOCATED, AS SHOWN, ON THE SIDE OPPOSITE THE PACKAGE ORIENTATION FEATURES.
- MOUNTING RECOMMENDATION IS SHOWN AS VIEWED FROM THE PCB TOP LAYER LOOKING DOWN TO SUBSEQUENT LAYERS.

**RECOMMENDED MOUNTING PATTERN\***  
For additional information on our Pb-Free strategy and soldering details, please download the On Semiconductor Soldering and Mounting Techniques Reference Manual, SOLDERRM/D.

### GENERIC MARKING DIAGRAM\*

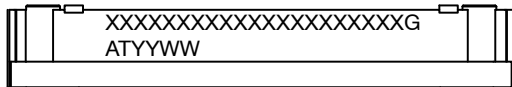

FRONTSIDE MARKING

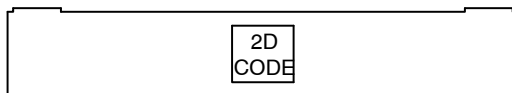

BACKSIDE MARKING

XXXXX = Specific Device Code  
G = Pb-Free Package  
AT = Assembly & Test Site Code  
YYWW = Year and Work Week Code

\*This information is generic. Please refer to device data sheet for actual part marking. Pb-Free indicator, "G" or microdot "▪", may or may not be present. Some products may not follow the Generic Marking.

<b>DOCUMENT NUMBER:</b>	<b>98AON15094H</b>	Electronic versions are uncontrolled except when accessed directly from the Document Repository. Printed versions are uncontrolled except when stamped "CONTROLLED COPY" in red.
<b>DESCRIPTION:</b>	<b>PIM32, 71x37.4 (SOLDER PIN)</b>	<b>PAGE 1 OF 1</b>

ON Semiconductor and are trademarks of Semiconductor Components Industries, LLC dba ON Semiconductor or its subsidiaries in the United States and/or other countries. ON Semiconductor reserves the right to make changes without further notice to any products herein. ON Semiconductor makes no warranty, representation or guarantee regarding the suitability of its products for any particular purpose, nor does ON Semiconductor assume any liability arising out of the application or use of any product or circuit, and specifically disclaims any and all liability, including without limitation special, consequential or incidental damages. ON Semiconductor does not convey any license under its patent rights nor the rights of others.

**onsemi**, **Onsemi**, and other names, marks, and brands are registered and/or common law trademarks of Semiconductor Components Industries, LLC dba "**onsemi**" or its affiliates and/or subsidiaries in the United States and/or other countries. **onsemi** owns the rights to a number of patents, trademarks, copyrights, trade secrets, and other intellectual property. A listing of **onsemi**'s product/patent coverage may be accessed at [www.onsemi.com/site/pdf/Patent-Marking.pdf](http://www.onsemi.com/site/pdf/Patent-Marking.pdf). **onsemi** reserves the right to make changes at any time to any products or information herein, without notice. The information herein is provided "as-is" and **onsemi** makes no warranty, representation or guarantee regarding the accuracy of the information, product features, availability, functionality, or suitability of its products for any particular purpose, nor does **onsemi** assume any liability arising out of the application or use of any product or circuit, and specifically disclaims any and all liability, including without limitation special, consequential or incidental damages. Buyer is responsible for its products and applications using **onsemi** products, including compliance with all laws, regulations and safety requirements or standards, regardless of any support or applications information provided by **onsemi**. "Typical" parameters which may be provided in **onsemi** data sheets and/or specifications can and do vary in different applications and actual performance may vary over time. All operating parameters, including "Typicals" must be validated for each customer application by customer's technical experts. **onsemi** does not convey any license under any of its intellectual property rights nor the rights of others. **onsemi** products are not designed, intended, or authorized for use as a critical component in life support systems or any FDA Class 3 medical devices or medical devices with a same or similar classification in a foreign jurisdiction or any devices intended for implantation in the human body. Should Buyer purchase or use **onsemi** products for any such unintended or unauthorized application, Buyer shall indemnify and hold **onsemi** and its officers, employees, subsidiaries, affiliates, and distributors harmless against all claims, costs, damages, and expenses, and reasonable attorney fees arising out of, directly or indirectly, any claim of personal injury or death associated with such unintended or unauthorized use, even if such claim alleges that **onsemi** was negligent regarding the design or manufacture of the part. **onsemi** is an Equal Opportunity/Affirmative Action Employer. This literature is subject to all applicable copyright laws and is not for resale in any manner.

## ADDITIONAL INFORMATION

### TECHNICAL PUBLICATIONS:

Technical Library: [www.onsemi.com/design/resources/technical-documentation](http://www.onsemi.com/design/resources/technical-documentation)  
onsemi Website: [www.onsemi.com](http://www.onsemi.com)

### ONLINE SUPPORT: [www.onsemi.com/support](http://www.onsemi.com/support)

For additional information, please contact your local Sales Representative at [www.onsemi.com/support/sales](http://www.onsemi.com/support/sales)

